

# FAMILY WATTERS

HOLY FAMILY CATHOLIC SCHOOL  
NEWSLETTER

## Product Design Exhibition Special



Cont. Pg 7

*"True love is both  
loving and letting  
oneself be loved"* Pope

*Francis*



**Also in this issue:**

- **Chinese Exchange Students**
- **Year 12 Activities Week**
- **Year 7 First Year Reflections**
- **Amelia Walas Piano Award**
- **Mountfitchet Castle Trip**
- **Year 7 Kingswood Residential 2019**



# HEADTEACHER'S MESSAGE

## **Summer holiday**

School closes for the Summer holiday today. We re-open for students on Thursday 5th Sept 2019 at the usual time.

## **Highlights of the summer term**

It's been a busy, busy term at Holy Family. Of course, traditionally the summer is exam season and our students sat lots of these. Results will be available in August. We've also seen school trips - from activities holidays for Yr 7 in Kent last weekend to Duke of Edinburgh expeditions to trips to the war graves in Ypres, Belgium and a whole range of day trips to destinations in and around London. We hope the students have enjoyed these excursions and benefited from them.

In sport we have had a successful programme of athletics and Holy Family students have won many medals in Borough, London and County events. In our Sports Hall we now have an honours board recognising the impressive representative achievements of our students and staff. Did you know we have international rugby, netball and football players in the PE Dept?

□ In music we thoroughly enjoyed last week's Music from the Movies and the varied programme of singing and musicianship that involved students from Yr 7 all the way to Yr 13. We also had the opportunity to welcome a group of Chinese students and their teachers for a week and were treated to a musical performance from them on their last day with us.

In May we had our diocesan RE inspection which went really well and we have seen many examples of our Catholic ethos in action. This has included House celebrations of Mass, retreats in school and at Aylesford Friary and charitable work including our annual Student Community Action Day where sixth formers spend a day helping others in the community.

## **Thank you**

Thank you to our staff, governors and to you our parents/carers for your excellent support of the school and our community. The school is truly a family and that is what makes it such a great place to work and study. We saw this sense of family recently when we held our alumni careers event at which a number of ex-students spoke to current students about their career pathways. We are always delighted to see and hear from former students and to welcome them back.

□

# HEADTEACHER'S MESSAGE

## **Staff moving on**

Each summer some staff move on from Holy Family, whether to retire, for promotion or through relocation elsewhere in the country. Of especial note this summer we say goodbye to our Assistant Headteacher, Mrs Feltham after 21 years service to the school and to Ms Litchfield after 15 years, we wish them both well in the future and thank them for all they have given to generations of Holy Family students.

It is a privilege to lead our school community and I, and all our staff, take great delight in all the many achievements of our young people. We hope for excellent exam results in August and we wish you all an enjoyable summer break.

**Please click [here](#) to read Dr. Stone's full Summer Letter.**

**Please continue to keep us in your prayers**

**Yours sincerely**

**Dr Andy Stone  
Headteacher**



# SOCIAL MEDIA CATCHUP



Holy Family Waltham  
@HFCSWaltham

A fantastic day trip to Le Touquet,  
France with year 8 today 🇫🇷 #aspire



16/07/2019, 21:42 from [Walthamstow, London](#)

||| View Tweet activity

8 Likes



Tweet your reply



@hfcswaltham



@hfcswaltham



Photo



hfcswaltham



Liked by crazyafro99 and 86 others

hfcswaltham This is the second week of work experience for our year 10s. We've been visiting them this week. Here's a pic of JP working hard at The Grosvenor House Hotel, Park Lane @marriottbonvoy #aspire



# Chaplaincy Corner



**Year 8 Retreat on the theme of Faith Journey** took place this week. We thank Mrs Isaac from Missio for introducing us to their work.

Since 1922, Missio has been the Catholic Church's official charity for overseas mission, bringing the hope of the Gospel where there is turmoil, poverty and uncertainty in the world, and where there Church is new, young or poor.

Mrs Isaac told us how Missio empowers local people to form and sustain communities of faith and train and nurture future leaders so that the vital work of the Church in the world can take place.

Students also took part in team building and prayer activities, during which time students painted stones for the Prayer Garden.

We are once again thankful for the Youthwave Team for their support.

Students had an opportunity to reflect upon their two years on the Walthamstow site and to look forward to starting on the Wiseman site in September.

The day started with Mass at Our Lady & St George and we thank Fr Nixon for his prayers for the Retreat.



# *Chaplaincy* Corner

Thanks to the generosity of students, staff and parents, this year over £1300 was sent to CAFOD. This was raised through a variety of ways during Lent.

And so we reach the end of the school year. I'm sure we're all hoping the wonderful weather continues for the school holidays.

A prayer for the school holidays  
Heavenly Father,  
thank you for this school;  
for friendships made,  
all it has given to us  
and all we have been able to give to its life.  
Bless us in these holidays  
and in the new beginnings that await us next term;  
through Jesus Christ our Lord. Amen.  
Ian Black, Prayers for all Occasions.

SUMMER DIGITAL  
SPECIAL

PRODUCT  
DESIGN

2019  
EXHIBITION



# Welcome to Product Design

Inventing Your Dream Is  
The First And Biggest Step  
Towards Making It Come True

Inspiring the next generation of Designers

@

H.F.C.S

WELCOME TO THE DIGITAL EXHIBITION OF  
OUR PRODUCT DESIGN PROJECTS 2019.  
OVER THE NEXT FEW PAGES YOU WILL FIND  
STUDENTS' GCSE PROJECTS. THEY WERE GIVEN  
THE TASK TO CREATE A PRODUCT FROM  
RECYCLED OR UP-CYCLED MATERIALS THAT  
WOULD BENEFIT A CUSTOMER. YOU WILL THEN  
FIND OUR A-LEVEL PROJECTS, THE STUDENTS'  
TASK WAS TO BE CREATIVE IN DESIGNING AND  
PRODUCING FURNITURE FROM RECYCLED OR  
UP-CYCLED MATERIALS. LATER YOU WILL  
FIND OUR YEAR 8 POP UP BOOKS AND A  
SPECIAL TREAT FROM BEN STABLES!





Hi. I'm Adebola Ladipo  
I Made a Dressing Table



My Project  
Addressing The Needs of People With Disabilities



Hi. I'm Alejandro Molina Santos  
I made a Solar Powered Light



My Project  
Supporting Developing Countries

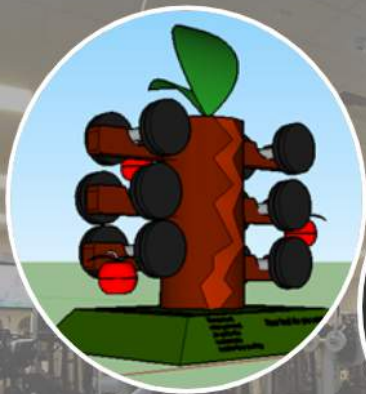

Hi, I'm Callm Cutmore  
I made a Weight Rack

My Project  
Encouraging a Healthy Lifestyle

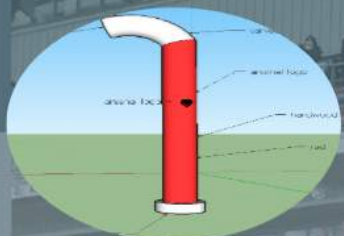

Hi, I'm Alexander Nish  
I made a Walking Stick

My Project  
Walking Stick



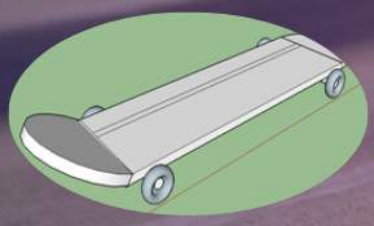
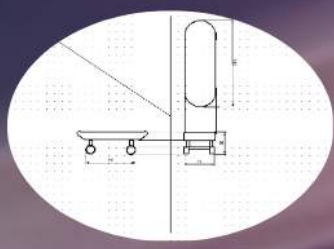

Hi. I'm Denis Kucukcakil  
I Made a Skateboard

My Project  
Encouraging A Healthy Lifestyle

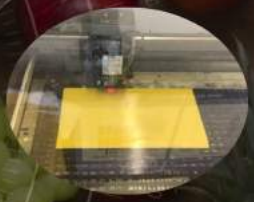

Hi. I'm Angel Agha  
I made a Fruit Lamp

My Project  
Encouraging A Healthy Lifestyle





Hi. I'm Celestin Llunga  
I made a Solar Powered Glow Clock

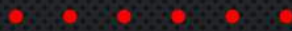

My Project  
Developing Countries & People Facing Disabilities

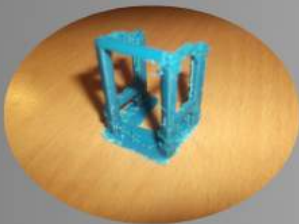
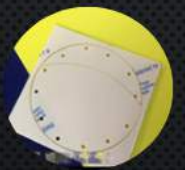

Hi. I'm Charles Kibuuka  
I made a Walking Frame



My Project  
Addressing The Needs of People With Disabilities

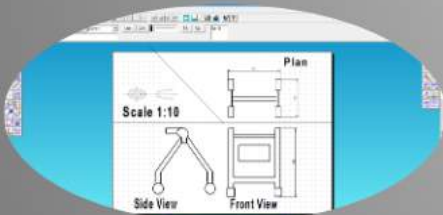



Hi. I'm Chris Tabi  
I made a Handheld Fan

• • • • •  
My Project  
Supporting Developing Countries



Hi. I'm Djamila Vanity  
I made a Mirror Clock

• • • • •  
My Project  
Supporting Developing Countries

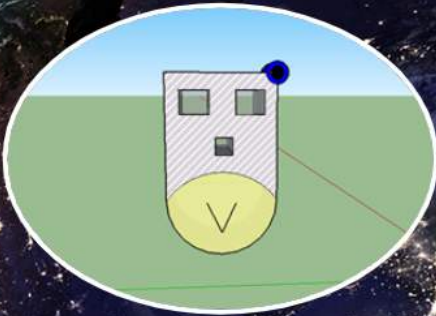

Hi. I'm Disanthan Robinson Jesukumaran  
I made a Solar Panel Light



• • • • •  
My Project  
Supporting Developing Countries

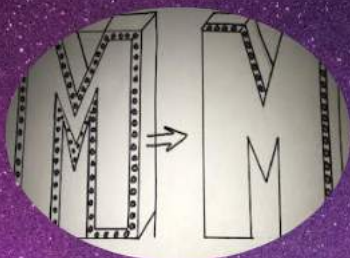
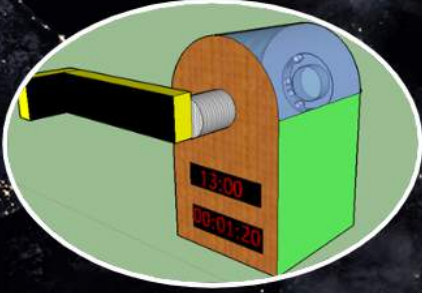

Hi. I'm Ermelinda Gjelij  
I made a LED Speaker Nightlight

• • • • •  
My Project  
Encouraging A healthy Lifestyle



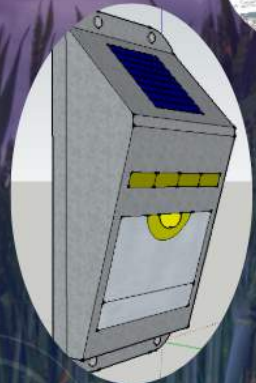
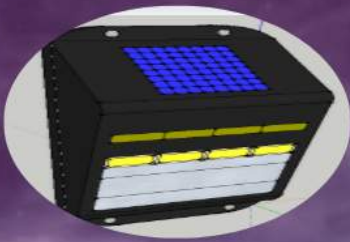

Hi. I'm Jan Makarewicz  
 I made a Solar Powered Light  
 My Project  
 Supporting Developing Countries

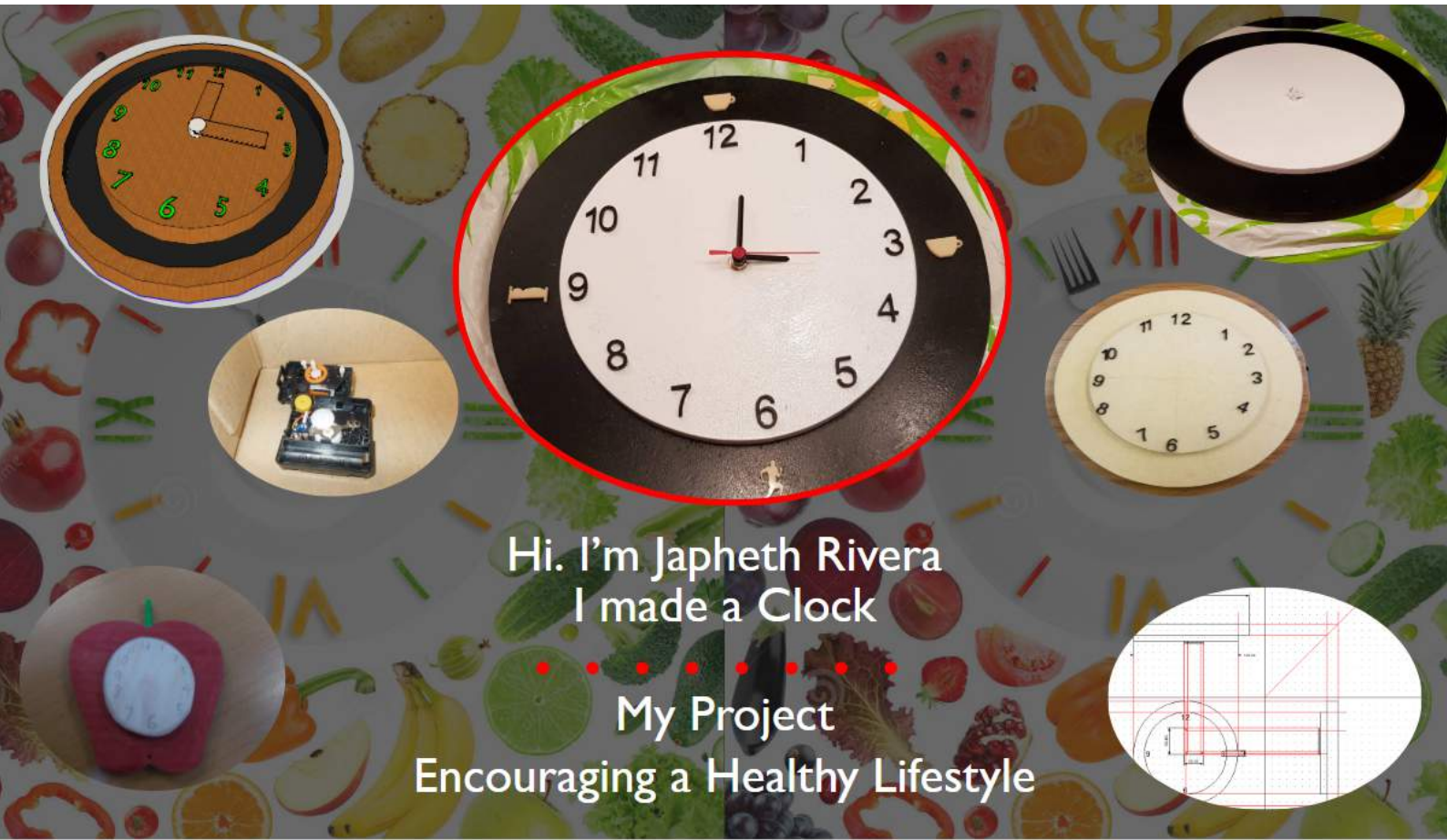

Hi. I'm Japheth Rivera  
 I made a Clock  
 My Project  
 Encouraging a Healthy Lifestyle

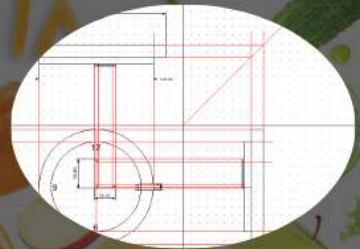



Hi. I'm Jezreel Copa  
I made a Umbrella Rain-water Catcher

• • • • •  
My Project  
Supporting Developing Countries



Hi. I'm Jason Quarry  
I made a Solar Charger Chair

• • • • •  
My Project  
Supporting Developing Countries



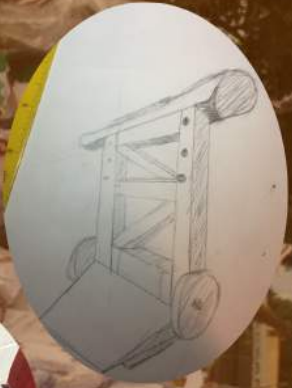

Hi, I'm Karl Medina  
I made a Load Carrier

My Project  
Supporting Developing Countries

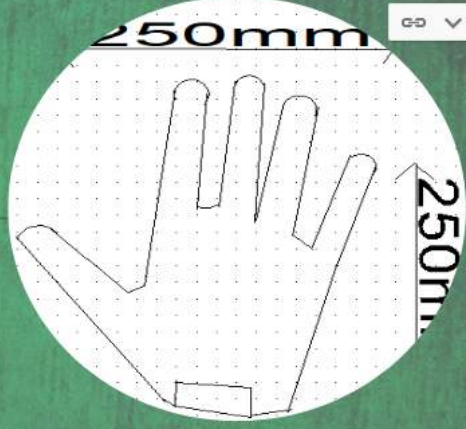
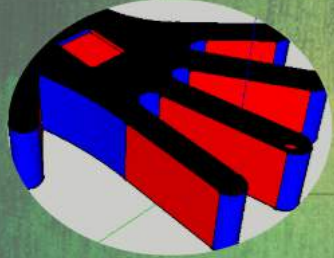
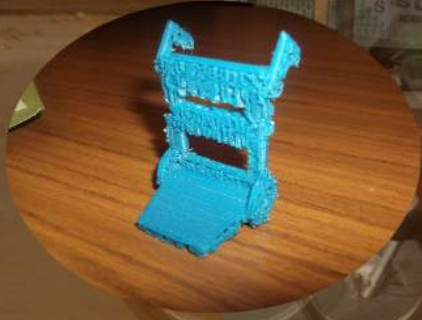
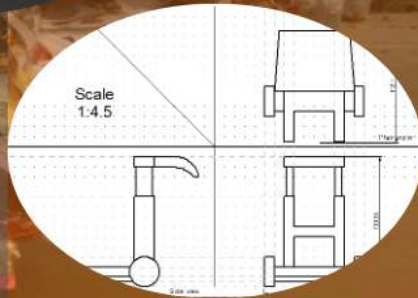

Hi, I'm John Dumas  
I made a Hand Print Alarm

My Project  
Addressing the Needs of People With Disability



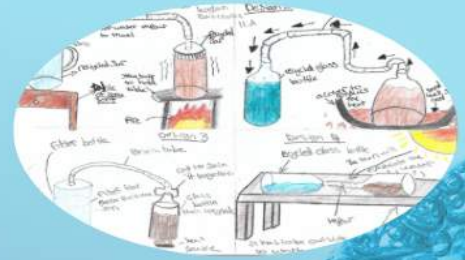

Hi. I'm Kaylan Bancroft  
I made a Water Purifier

My Project  
Supporting Developing Countries

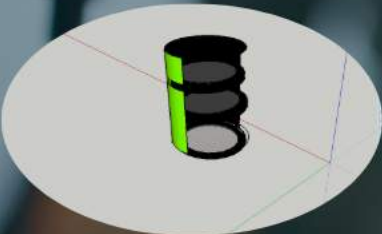

Hi. I'm Mark Ofori  
I made a Water Pump

My Project  
Supporting Developing Countries





Hi. I'm Mateusz Majchrowski  
I made a Water Filter

My Project  
Supporting Developing Countries



Hi. I'm Matan Soloman  
I made a Water Filter Bottle

My Project  
Supporting Developing Countries



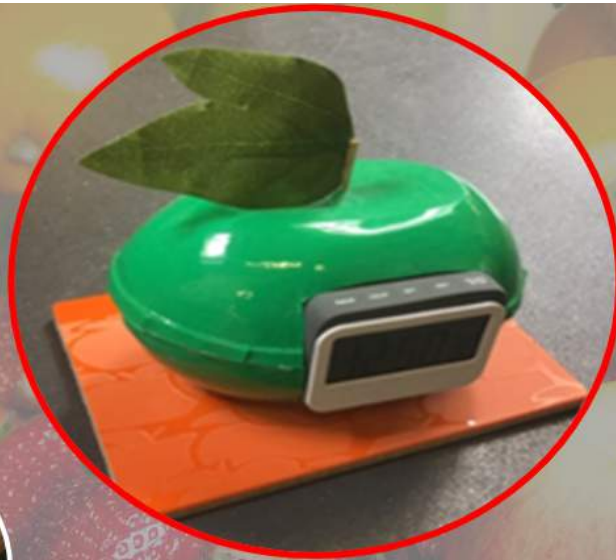
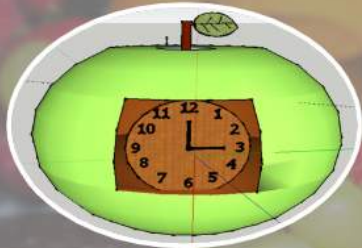

Hi. I'm Mobolaji Farombi  
I made a Fruit Shaped Clock

My Project  
Encouraging a Healthy Lifestyle



Hi. I'm Michael Deneke  
I made a Healthy Wooden Clock

My Project  
Encouraging a Healthy Lifestyle



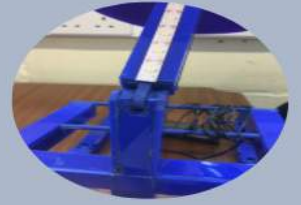
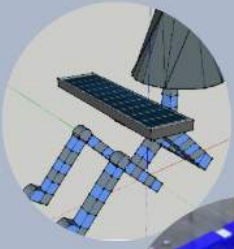

Hi. I'm Pawel Piskorski  
I made a Solar Panel Lamp



My Project  
Supporting Developing Countries

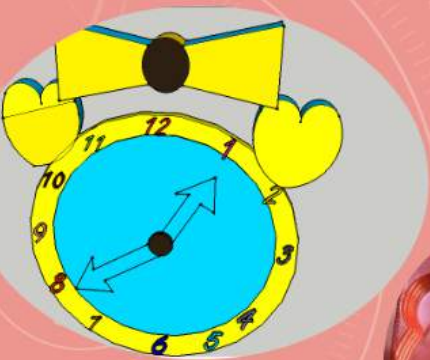
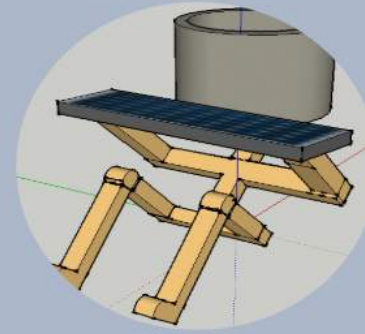

Hi. I'm Naomi Bangolu  
I made a Clock



Addressing the Needs of People With Disability

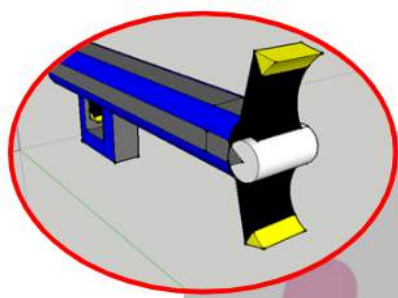

Hi. I'm Donald Junior Kazumba  
I made a Hand Grabber



My Project  
Addressing The Needs of People With Disabilities

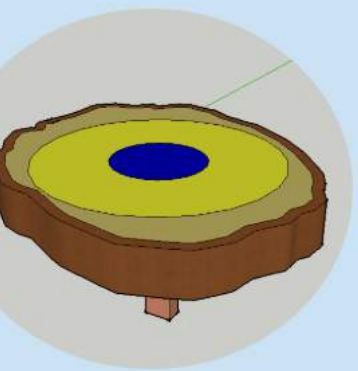

Hi. I'm Pearce John-Baptiste  
I made a Solar Powered Light



My Project  
Supporting Developing Countries



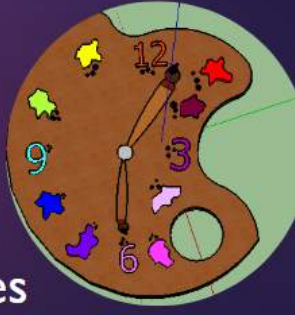

Hi. I'm Ranielle Simpson  
I made a Solar Powered Light



My Project  
Addressing the Needs of People with Disabilities

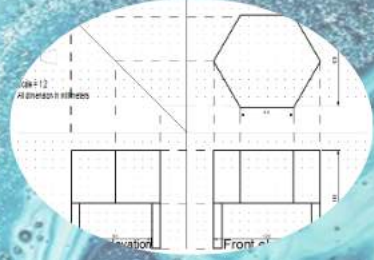
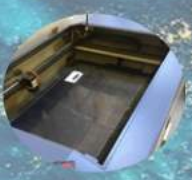

Hi. I'm Skye James-Samuel  
I made a Water Filter



My Project  
Supporting Developing Countries





Hi. I'm Stefan Elias  
I made a Knife for Parkinson's Disease



My Project  
Addressing The Needs of People With Disabilities

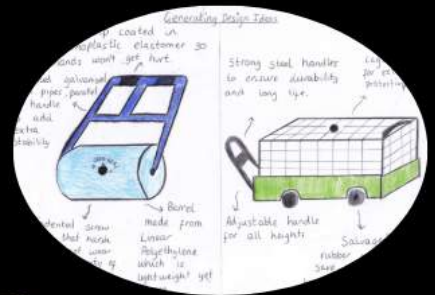

Hi. I'm Stephen Simon  
I made a Water Carrier



My Project  
Supporting Developing Countries

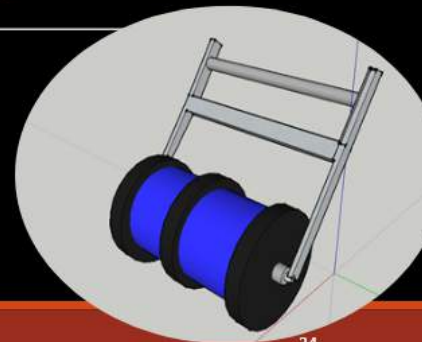



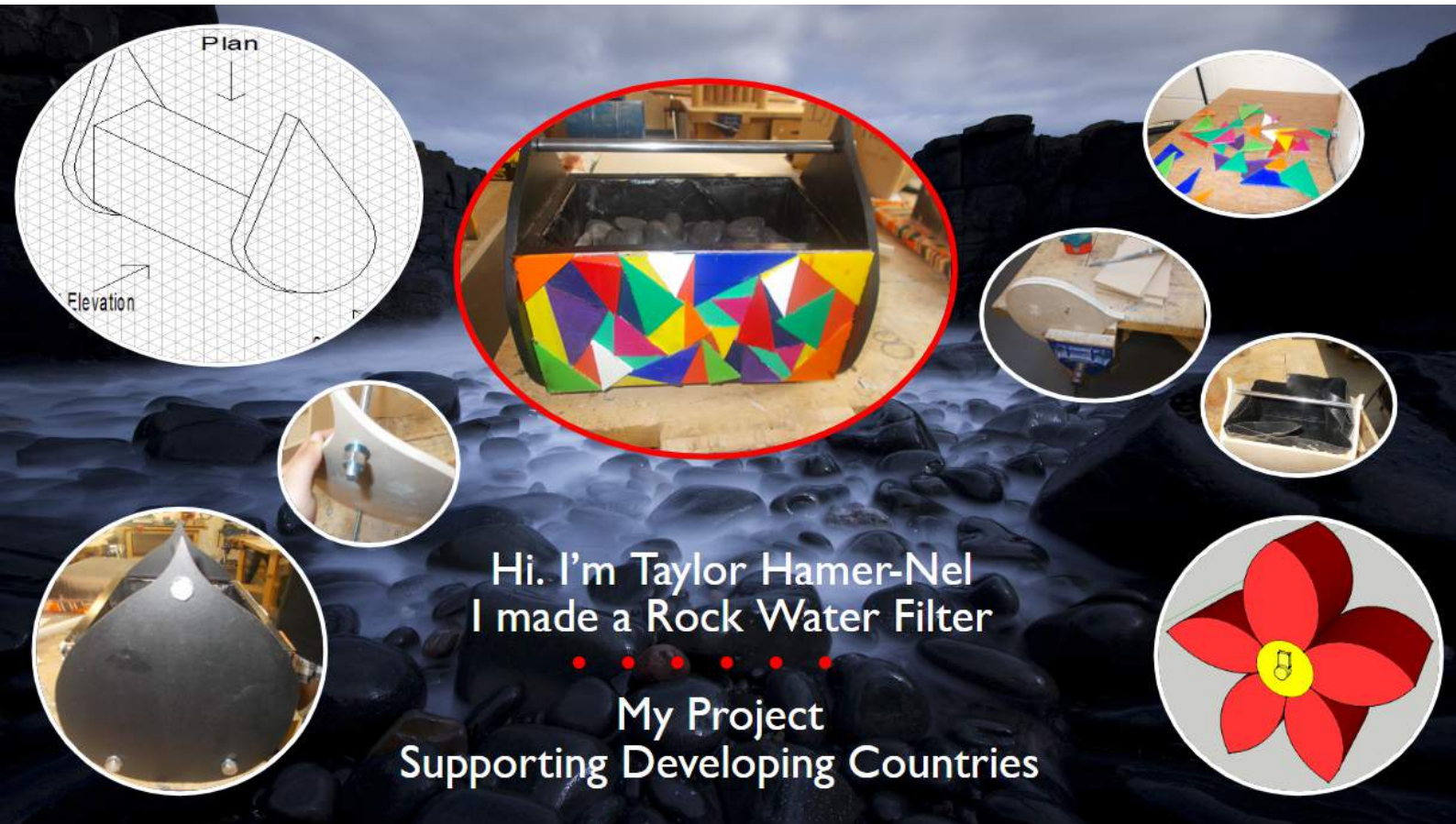

Hi. I'm Taylor Hamer-Nel  
I made a Rock Water Filter

• • • • •  
My Project  
Supporting Developing Countries



Hi. I'm Trinity Faye  
I made a Keyring

• • • • •  
My Project  
Supporting Developing Countries

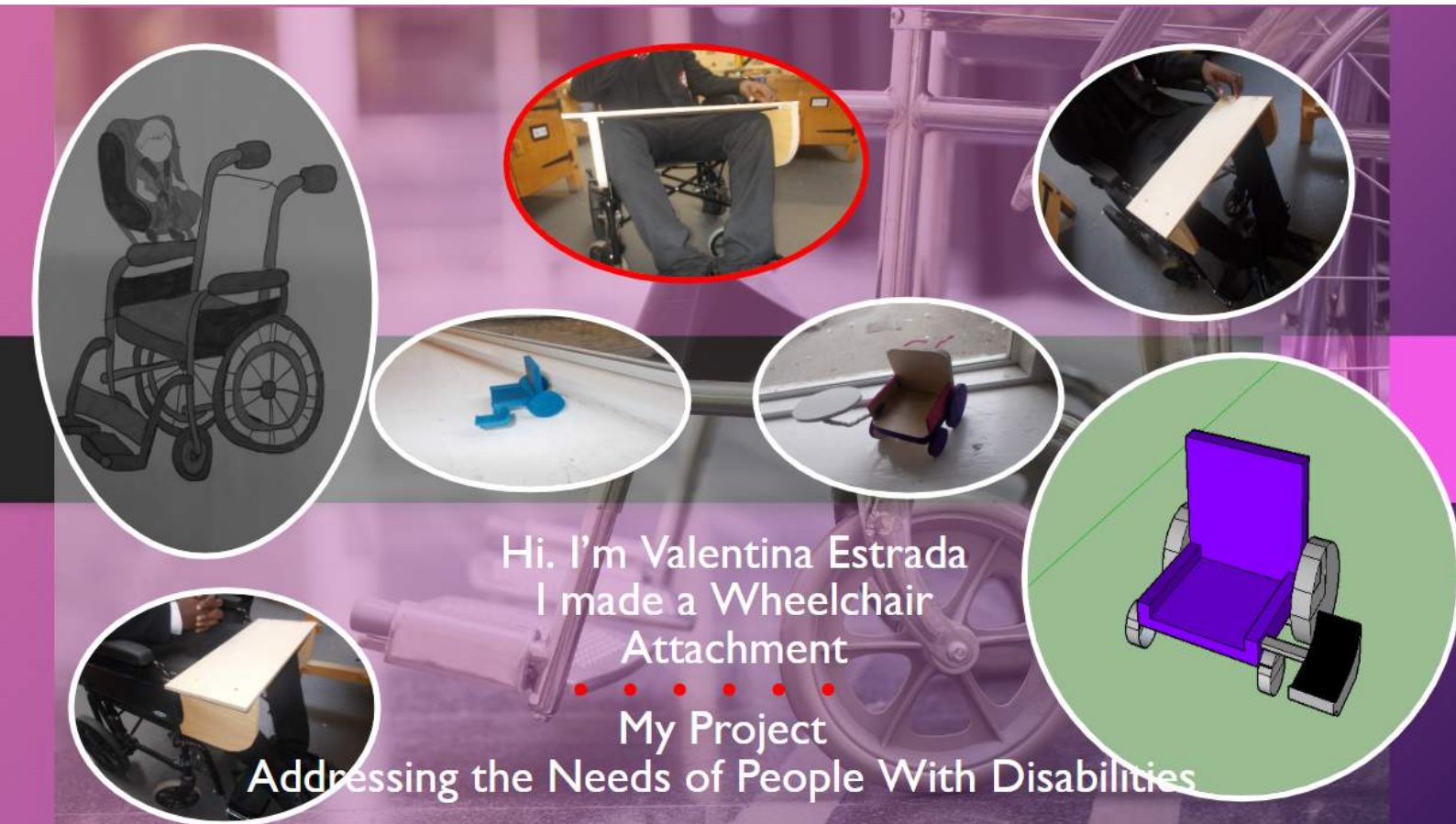

Hi. I'm Valentina Estrada  
I made a Wheelchair  
Attachment

• • • • •  
My Project

Addressing the Needs of People With Disabilities

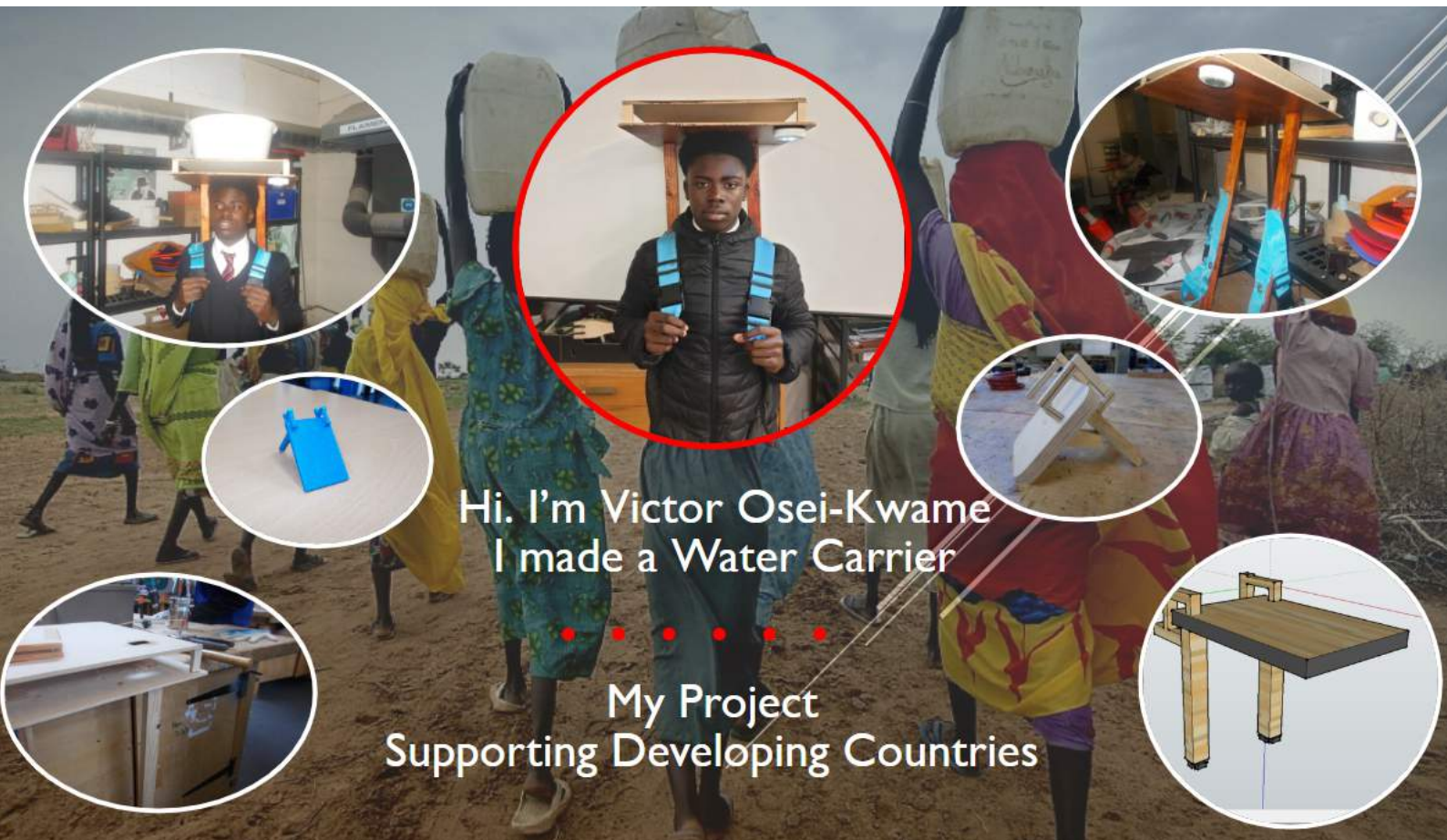

Hi. I'm Victor Osei-Kwame  
I made a Water Carrier

• • • • •  
My Project

Supporting Developing Countries

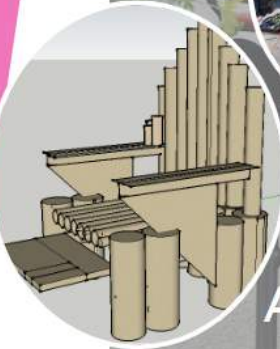
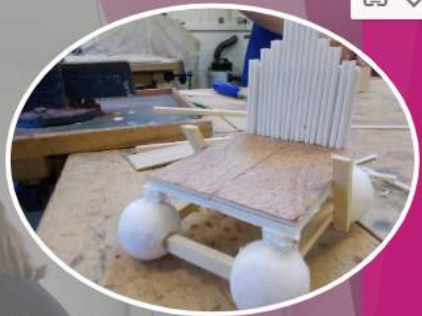

Hi. I'm Weronika Gizycka  
I made a Chair for Disabled People

My Project  
Addressing the Needs of People with Disabilities



Hi. I'm Adam Sygut  
I made a Solar Powered Light

My Project  
Supporting Developing Countries



A-  
LEVEL



EXPERIMENTING  
WITH  
RECYCLED  
MATERIALS















# YEAR 8 POP UP BOOKS

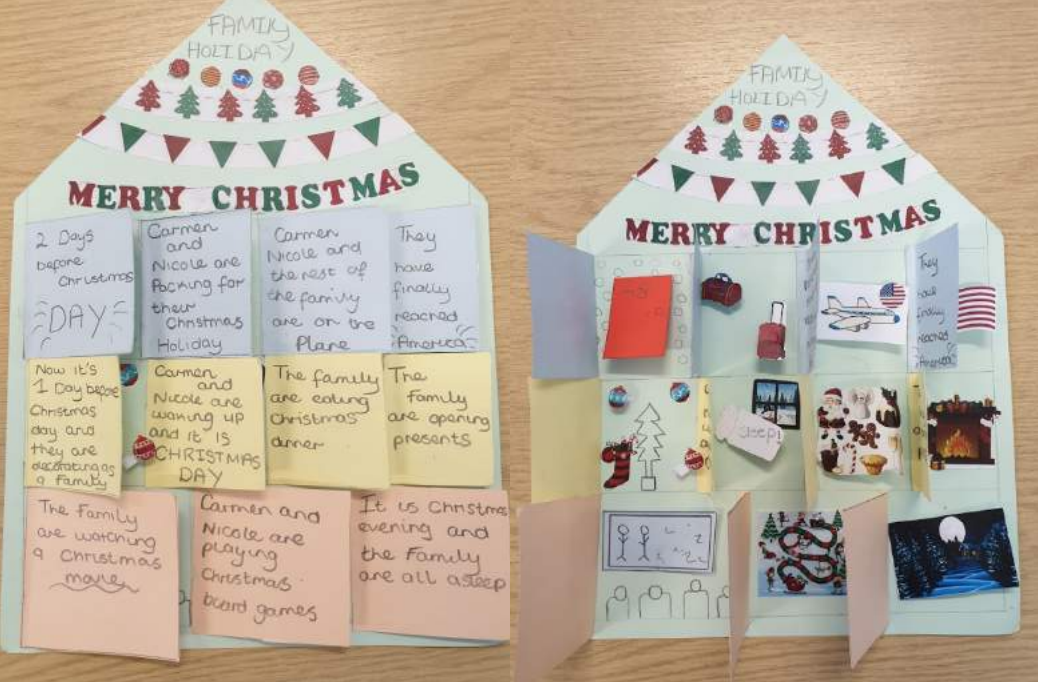

**Ben Stables' entry into the Tunnock's Teacake Challenge Competition**



**Ben had to decorate a plate with a Tunnock tea cake. He came third in the 11-14 age group.**

**Benjamin**



# International Students

AFFILIATED SCHOOL OF NINGBO  
UNIVERSITY

Last week we welcomed 25 students and three teachers from the Affiliated School of Ningbo University, 宁波大学附属学校, in China. We were delighted to be asked by True Education Partnerships to host the Chinese students who were visiting England to learn about our education system and culture. During their week with us at Holy Family the students were buddied up with our own year 9s and attended lessons as well as many other activities including; an English Culture workshop, a film night, an afternoon tea and assemblies. During their time in England the Chinese students also got to see some tourist attractions including going on the London Eye. On the final day of their visit we held a special goodbye ceremony. The Chinese students performed some musical pieces and dance. Gifts were exchanged and lots of photos were taken. Our year 9 students were very sorry to see their buddies leave.

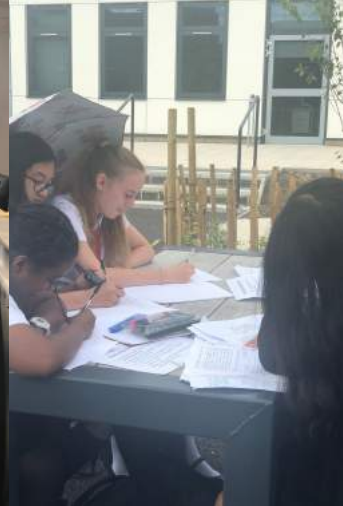

# Afternoon Tea & Buddy Film Night



# In a live descriptive writing session with Mrs Cameron students wrote about what they saw around them. Here are some lovely notes from our Chinese guests...

Today is a great day.  
The weather is good — sunny but not hot. We studied for five days in the Holy Family Catholic School. I consider that the British are always super out-going and friendly. I made friends with my buddy called Zofia. She was more than kind and nice. Surprisingly, she gave me many gifts that is my favorite — snack. I like her so much.

## A fantastic experience

This experience is nothing but fantastic.

School day is approaching. The sky become clear and the weather is quite lovely. Students from the holy family catholic school are friendly and hospitable. They introduce themselves with a big smile and joyful voice. They take us to their classroom and have lessons with them. Although we can't understand their discussion definitely, ~~we~~ we ~~had~~ had a great time. ~~It's~~  
To my surprise, their maths and science class are more than easy.

Personally,

In the play ground of the school, there are many benches and desks. The buildings there are not tall but really pretty. Many students like doing sports there when they finish their classes. They can play basketball, soccer and badminton. And some of students also like reading and writing under the trees.

In the classrooms, all the students and teachers are hard-working and warm-hearted and friendly. They ~~always~~ always be active in class. The food in the dining hall are really delicious!

The ~~weathy~~ weather there is warm and sunny. So all of us are very enjoyable. So I think the school is a good place to enjoy life.

徐世航

I'm so glad to come to this school. It's very beautiful.

~~It's very beautiful.~~ There are many buildings, such as gyms, music rooms and art rooms. They are big so I like them very much. On the playground, there are two ping-pong tables. I like playing ping-pong because it's interesting. I always have fun there.

The food there is so delicious that I am full every day. They have Chinese food and English food. I really like the noodles! I also want to drink the strawberry milk, too.

I think the English students are very friendly. They are kind to me. When I have some questions, they will tell me the answer to the questions! I love having classes with my friends.

I hope that I can come to this school again. I will miss them in China.



Lucy, 20

## Clouds On The Other Side of the Ocean.

Sometimes, I suddenly want to be a bird from the sky.

Out of the sky cut apart by endless tall build building  
To hug the beautiful clouds at the end of the world.

~~To dance with the colorful sky in~~  
To dance with the pure beautiful of blue and white behind the mist.

Will I still ~~reme~~ remember the blue sea that had been endless?

Will I still remember the flower that bloom in the wild? Q

Or the ~~firework~~ colorful fireworks in the most-deep-night sky?

All the sound is stripped from the beard

12.07.19. 星期四

Sunny.

It's a ~~sunny~~ sunny day today. It's also the last day in London.

I like the food in London. It's really delicious. The students here are friendly. They are interesting in Chinese. <sup>learning Chinese.</sup>

This school is bigger than my mine in China. It's also very tidy. There are many trees and flowers in it, and there are also many classroom here. It's different from the schools in China.

We only have 3 lessons every day, and every lessons are all interesting for me. I like the history lesson best. It's nice. ~~We~~ I can learn lots of things on this lesson.

I'm sad to leave this school. I don't want to leave here. I like Holy Family very much.

# Closing Ceremony and Gift Exchange





# YEAR 12

## ACTIVITIES WEEK 2019

Year 12 have been very busy in the last two weeks with different activities to celebrate the end of term and to help with their next steps. They attended a number of activities designed to expand their experiences beyond their academic studies.

On the 2nd of July the whole of Year 12 took part in the annual Community Action Day where they volunteered their time to help in different local groups. This was an excellent day and the feedback was superb! The places that volunteers went to include; Epping Forest Conservation, St John's School, OLSG, St Joseph's, Spitalfields City Farm, Alliston House, Silver Surfers, Lloyds Park and Christ the King Church.



On Monday, fifteen ex-Holy Family students attended our alumni day, where they spoke to small groups of students about their careers, what their day to day work involves and the paths they took to get there. This was an incredibly insightful day for students and many took the opportunity to network with our alumni to ask them further questions and gain useful hints and tips. A big thank you to all the Alumni who volunteered their time to come and speak to our students and offer them work experience and mentoring.

# YEAR 12

## ACTIVITIES WEEK 2019

Tuesday was the annual trip to Sussex University and Brighton. Students had a campus tour of the university and attended talks about university life, how to choose which university to attend and what to include in their applications. They then got to spend a few hours in Brighton town centre enjoying ice cream in some wonderful weather! Thank you to the University of Sussex for hosting us and giving really interesting talks.



Wednesday saw a new addition to the activities week - our London cultural and historical Scavenger hunt. In teams, students were given the names of 10 historical sites in London, along with a question that related to something at the site. They then had to plan the most efficient route to visit all 10 sites and take a photo to prove they had actually been there and not cheated via the internet! Try out your general knowledge of London landmarks and see if you can answer the same questions (see the end of this feature for the questions!)



# YEAR 12



# ACTIVITIES WEEK 2019

After a lengthy stewards inquiry regarding the steps in Piccadilly Circus, the winners were House I (Julia, Elyse, Joyce, Megan, Aji, Ruby, Noby and Anitha) and S (Mak, Joel, Victor, Cameron and Ashley). Well done to everyone for all their efforts! Also see above for Mr Delf enjoying the day!



Thursday was our UCAS and careers day where students received information on how to construct personal statements and complete the online UCAS application form for university. A big thank you to Leicester University for giving the talks to students.

Finally, Friday saw our annual end of year retreat to Aylesford Priory in Kent. As ever this was a fantastic end to the school year which gave students the opportunity to get out of the city and spend some time in quiet reflection on how the past year has gone and what their aims are for the future. We finished with a very competitive game of rounders!



# YEAR 12

## ACTIVITIES WEEK 2019

Site of interest	Order of visit (1-10)	Question to answer!
Cleopatra's Needle		Where was the needle abandoned during a storm?
Covent Garden		Is Wittard's of Chelsea in the South Hall or the North Hall of the market?
The Queen Victoria Memorial (in front of Buckingham Palace)		What type of animals are on the plinths around the statue?
The steps of St Paul's Cathedral		What time is Mattins on weekdays?
Tower Bridge		Who opened the Bridge and on what date?
Leicester Square		A statue stands in the centre of the square – who is it?
The Monument to the Great Fire of London		What rhyme is written on the seats next to the monument?
Piccadilly Circus		What shape are the steps surrounding the statue of Eros?
Shakespeare's Globe		According to the Blue Plaque, who recreated the Globe Theatre?
Trafalgar Square		There is a statue of a King on a horse somewhere in the square. Which King?

## Year 7 First Year Reflections

# *Dear past me...*

Dear Victoria at the beginning of year 7,

I never understand why you were so scared, year 7 isn't all that bad. In the beginning I was really intimidated by all the homework I had to complete and I was scared that I would never meet any new friends. I remember my first day like it was yesterday, the butterflies in my stomach, the feeling that I had to make a great first impression. I remember also walking through the doors of Holy Family for the first time and being greeted by Mrs Murray who was extremely nice to me. Meeting back with my class was very nerve wracking and so was having my first ever lessons and meeting my subject teachers. They were all so nice which really satisfied my fear of them being too strict or not welcoming. Meeting my form tutor and my head of year was amazing, Mr Norman is so funny and the best form tutor ever and Miss St Aimie is the best head of year that I could wish for. I remember coming back home after the first day of school saying to myself "I am going to love this school", and I really do

After this the days came and went in the blink of an eye and I could barely finish turning my head before it was the end of the day, I got used to the algorithm so quickly and I now I'm nearly in year 8. Now I feel like I know the people that I see everyday at school so well that sometimes I think that they used to go to my primary school!! I also got used to the amount of homework that I had to do and handled it well by separating up my time so that I had enough time to do each.

Looking back on this year, along with all the good things, there are some bad things that I would change if I ever got the chance to go back to the time I started year 7. These bad things are, for example, getting a detention, forgetting to do my homework or not being organised. To change this I would check my homework every night and make sure to always be careful with what I do in order to not get a detention and I would always check my pencil case to make sure I have my pens and general equipment. For the year ahead I will make sure not to get any detentions and I will do this by organising myself

If I had to say one thing to you, past Victoria, I would say, don't be scared because you will get used to the timetable very quickly and you will make friends easier than you think! Also don't be worried about being judged because no one will care as long as you have a good heart. In general, this year was a really amazing start to secondary for me especially with the help of the teachers at my school who were very helpful and nice to me all year round. This was an amazing year and I hope for the same in year 8!!

From Victoria at the end of the year



## Year 7 First Year Reflections

# *Dear past me...*

Dear Patrick,

In year 7, don't worry what people think of you. You're your own person and it doesn't matter if people hate or love you treat everyone equally and with respect. Always turn the other cheek. Try to be kind to people even if they are rude to you.

Year 7 is so enjoyable... as long as you have a positive mindset. If you are always thinking negatively about yourself then you will not succeed.

In year 6 things are different because you are less independent - you have one teacher and one classroom. From the first day of year 7, you will feel much more independent for you will have to do your own revision, research and there will be much more homework.

If you want any advice from me then I would recommend staying on top of both your homework and revision. I know there is a lot, but trust me, it feels VERY good when you know you have no homework for the rest of the week. If you have a free Friday and you want to catch up on some homework I would completely recommend it so you do not have to tackle it on the weekend

As you will be going to a new school, this gives you many new opportunities: such as making new friendships and keeping old ones. You will also be able to register in new clubs in-school and out of school. The clubs are fun and enable you to meet new people and develop new skills. You should in enroll as many as possible.

There will be some mistakes on the way to year 8, but just know I believe in you!

Yours sincerely,  
Patrick

*Thank you to Patrick McCormack, 7P and  
Victoria Chamulak, 7R for these lovely  
letters.*

# AMELIA WALAS



AMELIA  
WITH HER  
GRADE 1  
CERTIFICATE  
FOR PIANO

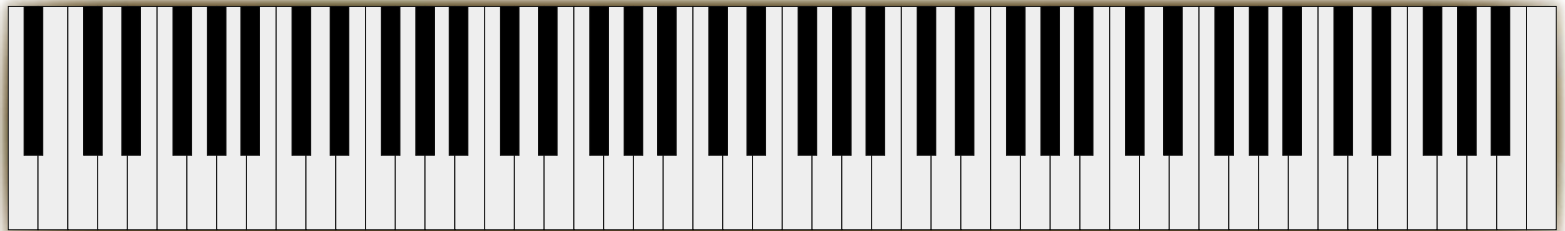

# Mountfitchet Castle Trip

DARNEL NORVILLE 7

At Mountfitchet Castle there were animals such as goats and we were allowed to feed them. Inside the castle there were churches and tall buildings which contained medieval items like swords, shields and helmets. The buildings were medieval and it seemed like I was in the Middle Ages. If there was another trip like this one I would definitely go to it without hesitation. It was simply amazing! This one object, called a catapult, fired water balloons high in the sky. In medieval times they would have used rocks instead of water balloons.



# Year 7 Kingswood Residential 2019



# MATHS CORNER

## MATHS JOKES

Why do plants hate maths?

Because it gives them square roots.

Why shouldn't you let advanced maths intimidate you?

It's really easy as pi.

Why are obtuse angles so depressed?

Because they are never right.

Are monsters good at maths?

Not unless you count Dracula.

Parallel lines have so much in common

It is a shame they will never meet

Why is the number 6 so scared of 7?

Because 7 Eight 9

Which integer is the coldest?

The Number one.

Why are circles so hot?

Beacuse they are 360 degrees.

By Claude in 7P

$$\int (x \pm a)^2$$

$$\sum = n-1$$

$$\frac{A-C}{C}$$

$$\phi = \sqrt{\frac{\sum (x-m)^2}{n-1}}$$

$$S = \int_2^{10} 5t dt$$

$$\sin \alpha$$



#LEYTONPLAYSTRONG



# Girls Only Football Development

Girls aged 3 to 6 years (Infants)  
Saturdays 9 to 10am

Girls aged 7 to 11 years (Juniors)  
Saturdays 10am to 1130am

Girls aged 11 to 16 years (Seniors)  
Saturdays 10am to 1130am

Book online:  
[afcleyton.co.uk](http://afcleyton.co.uk)

First 2 sessions are free

AFC Leyton Home Ground, Walthamstow, E4 8ST  
White gates behind Sainsburys Low Hall (off Billet)



AFC Leyton Girls Football Club  
Salisbury Hall Playing Fields  
& Fairlop Powerleague

Web: [www.afcleyton.co.uk](http://www.afcleyton.co.uk)  
Email: [info@afcleyton.co.uk](mailto:info@afcleyton.co.uk)

July 2019

## New Player Trials Girls Only

**CLUB:** AFC Leyton

**DATE:** Sunday 21 July 2019

**TIME:** 945 – 1130am

**LOCATION:** Salisbury Hall Playing Fields, E4 8ST

**ELIGIBILITY:** School years 3 to 11 (aged 7 to 16)

**BOOK:** [afcleyton.co.uk/new-player-trials/](http://afcleyton.co.uk/new-player-trials/)

### ABOUT OUR CLUB

AFC Leyton is the only dedicated female youth football club in east London. We are fully committed in covering all aspects of football with a common aim of building self-esteem, confidence and life skills.

We operate as a competitive community football club and we are an Arsenal sister club. We also have links to local Regional Talent Centres to ensure a strong pathway for talented players.

**Our final open trials will be held on Sunday 21 July at 945am.**

All girls that are interested in playing football can come along regardless of their experience and skill level. Our club has something for everyone:

Elite players join our league teams, aspiring players join our development teams, and beginners join our foundation sessions.

Our coaches are all DBS checked, safeguarding trained, hold emergency first aid certificates and all have coaching qualification including Level 1FA, Level 2 FA and UEFA B qualified coaches.

Girls come to us from throughout East London and some of our players have gone on to higher levels of football including FA Regional Training centres such as Arsenal FC, Millwall FC, Charlton RTC as well as England U15 training Camps.

Yours faithfully  
Tom Cruse  
**Head Coach - AFC Leyton**



Wishing  
everyone a  
great summer  
holiday!

**All students return to school on  
Thursday 5th September, 8.40am**